



Carcase/Front/Applications	Colour code
Alpine white / App. Jackson hickory colour, White faux leather	A260B



Alpine white



Jackson hickory colour



Carcase coloured handles; Handle strips in contrast colour

Beds, matching pieces, hinged- and sliding door wardrobes.  
Beds with white faux leather padded headboard.  
Passepartouts with or without lighting.  
Drawers with base rail, cushioned self-closing mechanism.  
All hinged doors incl. self-closing mechanism.



■ Matching rauch ORANGE + accessories 1.0 can be found after the wardrobes.



Very easy to plan using:

**furn plan**

Supplier: Rauch Möbelwerke GmbH

# Quality features

rauch ORANGE +



Interior colour  
Texline  
colour



22 mm  
shelves



EASY  
SLIDE

Metal guide  
rails, Optional  
dampers for  
sliding doors

Exception: Lias/Yubari models with damping



Drawers with  
base rail,  
cushioned self-  
closing



Hinged doors  
with thick edges

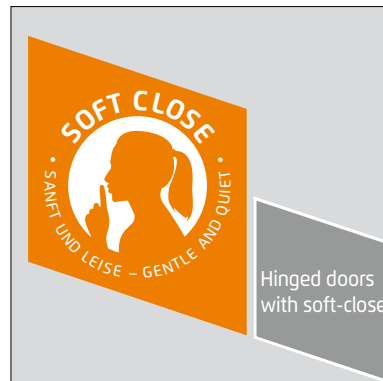

Hinged doors  
with soft-close



See rauch ORANGE + ACCESSORIES 1.0/1.1 for robe accessories.

## Quality and material



### 10 years rauch manufacturer's warranty.

Warranty terms and conditions on [rauchmoebel.com/garantie](http://rauchmoebel.com/garantie) and in information enclosed with the product.



### Colour

Furniture with colour finish has an evenly attractive, hard-wearing surface.



### Load-bearing capacity

The load limits for all furniture and extras can be found in the load table at: <https://qrco.de/rauch-belastungstabelle>



### WOODMAX chipboard

This healthy green-wood chipboard was designed specifically for use in living areas. Our Woodmax chipboard is made only from pollutant-free small-diameter logs and windfall timber from sustainably managed forestry operations in regional woods.

### Our natural raw material

Rauch has won various awards for the material used in its boards. Strict tests by impartial institutes consistently confirm that our materials and processes are not harmful to health.

## Award-winning and certified

### made in GERMANY

Nachhaltig gefertigt



[www.blauer-engel.de/1uz38](http://www.blauer-engel.de/1uz38)

- emissionsarm
- Holz aus nachhaltiger Forstwirtschaft
- In der Wohnwelt gesundheitlich unbedenklich



Timeless  
look

Attractive  
front designs

Durable  
product  
quality

Excellent  
furniture  
fittings

compre-  
hensive acces-  
sories

Carcase/Front/Applications	Colour code
Alpine white / App. Jackson hickory colour, White faux leather	A260B

BEDS		Padded headboard in white faux leather, bed frame in carcase colour with applications; adjustable fittings for mattress height						
<b>W 160 cm</b> <b>W 180 cm</b> Inlet depths slatted frame: (Upper edge of bed side to support height): <ul style="list-style-type: none"> <li>• 12,6 cm</li> <li>• 14,9 cm</li> <li>• 17,2 cm</li> <li>• 19,6 cm</li> </ul>		<p>* Surcharge for bespoke length:</p>		<p>* Surcharge for bespoke length:</p>				
					bed	bed	bed	bed
					160/190 ↔167 cm †105 cm ↗200 cm BG 65	160/210 BG 62 *	180/190 ↔187 cm †106 cm ↗200 cm BG 85	180/210 ↔187 cm †106 cm ↗220 cm BG 82 *
					160/200 ↔167 cm †105 cm ↗210 cm BG 60	160/220 BG 63 *	180/200 ↔187 cm †106 cm ↗210 cm BG 80	180/220 ↔187 cm †106 cm ↗230 cm BG 83 *
Article	Price	<b>81A7</b>	<b>81A7</b>	<b>81A4</b>	<b>81A4</b>			



BEDS		Padded headboard in white faux leather, bed frame in carcase colour with applications; adjustable fittings for mattress height				
<b>W 200 cm</b> Inlet depths slatted frame: (Upper edge of bed side to support height): <ul style="list-style-type: none"> <li>• 12,6 cm</li> <li>• 14,9 cm</li> <li>• 17,2 cm</li> <li>• 19,6 cm</li> </ul>		<p>Surcharge for bespoke length:</p>				
			bed	bed		
			200/190 ↔207 cm †106 cm ↗200 cm BG 15	200/210 ↔207 cm †106 cm ↗220 cm BG 12 *		
			200/200 ↔207 cm †106 cm ↗210 cm BG 10	200/220 ↔207 cm †106 cm ↗230 cm BG 13 *		
Article	Price	<b>81A4</b>	<b>81A4</b>			

BED PANELS		Rear panel wall in application colour. Drawers with carcase colour. Drawers with base rail, cushioned self-closing mechanism.							
		<p>Pair of bedside tables with lighting art. 61A1</p> <p>2 x 380 cm</p> <p>TRAFO 12V 220V</p> <p>2 x 3W</p> <p>LED / DEL 12V 220V</p>	<p>Please order using colour code A0066.</p> <p>Swivel light art. 99LP</p> <p>2 x 140 cm</p> <p>TRAFO 12V 220V</p> <p>2 x 2,5 W</p> <p>LED / DEL 12V 220V</p>	<p>hanging bedside table pair with panel</p> <p>with lighting, with shelf</p> <p>↔50 cm †100 cm ↗45 cm</p>	<p>This product contains a light source of the energy efficiency class F.</p> <p>EPREL 766931</p>				
						Article	Price	<b>61A1</b>	<b>99LP</b>

# MARCELLA



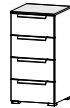

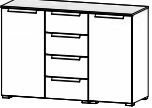
rauch ORANGE +

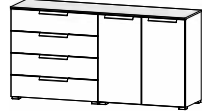
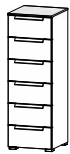
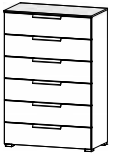
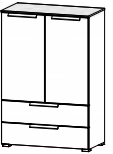
Carcase/Front/Applications	Colour code
Alpine white / App. Jackson hickory colour, White faux leather	A260B

MATCHING PIECES		Top in application colour. Drawers with base rail, cushioned self-closing mechanism.						
					chest			
					4 drawers	chest		
					4 drawers	4 drawers	1-door, hinged left, 4 drawers	2-door, 4 drawers
					↔40 cm †81 cm ↗42 cm	↔80 cm †81 cm ↗42 cm	↔80 cm †81 cm ↗42 cm	↔120 cm †81 cm ↗42 cm
Article	Price	<b>6D25</b>	<b>6D26</b>	<b>6D72</b>	<b>6D75</b>			

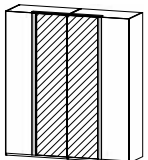
MATCHING PIECES		Top in application colour. Drawers with base rail, cushioned self-closing mechanism.						
		<p>can be mounted on the left or right</p> 			chest			
					2-door, 4 drawers	chest		
					↔160 cm †81 cm ↗42 cm	6 drawers	6 drawers	2-door, 2 drawers
					↔160 cm †81 cm ↗42 cm	↔40 cm †119 cm ↗42 cm	↔80 cm †119 cm ↗42 cm	↔80 cm †119 cm ↗42 cm
Article	Price	<b>6D76</b>	<b>7D32</b>	<b>7D33</b>	<b>7D37</b>			

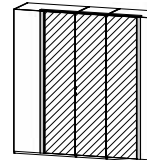
Carcase/Front/Applications	Colour code
Alpine white / App. Jackson hickory colour, White faux leather	A260B

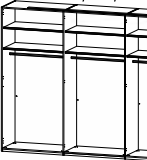
WARDROBES		Hinged door wardrobes with mirror doors. Handle strips and cornices in application colour.		
<p>All hinged doors incl. self-closing mechanism.</p> <p>See rauch ORANGE + ACCESSORIES 1.0 for robe accessories.</p> 	  	 <p>100/100</p>	 <p>100/50/100</p>	 <p>100/100/100</p>
		hinged door wardrobe	hinged door wardrobe	hinged door wardrobe
		4-door, 2 mirror doors	5-door, 3 mirror doors	6-door, 4 mirror doors
		↔201 cm †225 cm ↗63 cm	↔251 cm †225 cm ↗63 cm	↔301 cm †225 cm ↗63 cm
Article	Price	<b>58M7</b>	<b>58M8</b>	<b>58M9</b>

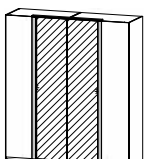
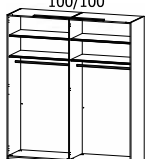
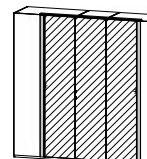
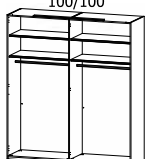
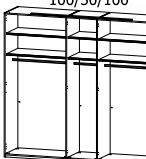
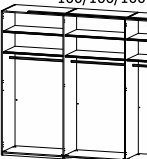
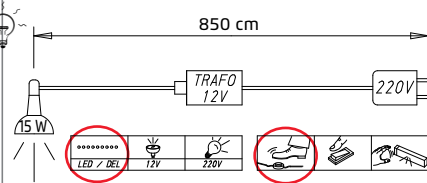
WARDROBES		Hinged door wardrobes with mirror doors. Handle strips and cornices in application colour. Handle strips with lighting.			Lighting
<p>All hinged doors incl. self-closing mechanism.</p> <p>See rauch ORANGE + ACCESSORIES 1.0 for robe accessories.</p> 	  	 <p>100/100</p>	 <p>100/50/100</p>	 <p>100/100/100</p>	
		hinged door wardrobe	hinged door wardrobe	hinged door wardrobe	
		4-door, 2 mirror doors, with lighting	5-door, 3 mirror doors, with lighting	6-door, 4 mirror doors, with lighting	
		↔201 cm †225 cm ↗63 cm	↔251 cm †225 cm ↗63 cm	↔301 cm †225 cm ↗63 cm	
Article	Price	<b>58V7</b>	<b>58V8</b>	<b>58V9</b>	<p>This product contains a light source of the energy efficiency class E.</p> <p>EPREL 768978</p>

# MARCELLA

rauch ORANGE +

Carcase/Front/Applications	Colour code
Alpine white / App. Jackson hickory colour, White faux leather	A260B

WARDROBES		Sliding door wardrobes with mirror doors. Handle strips in application colour.			Door dampers for sliding door robes						
<p>See rauch ORANGE + ACCESSORIES 1.0 for robe accessories.</p>							<p>Please order using colour code A0066.</p>				
								sliding door wardrobe	sliding door wardrobe	sliding door wardrobe	set of 2 dampers for sliding wardrobes
								2-door, 1 mirror door	2-door, 1 mirror door	3-door, 1 mirror door	of 2-4 door sliding door wardrobes
	↔201 cm ↑223 cm ↙68 cm	↔251 cm ↑223 cm ↙68 cm	↔301 cm ↑223 cm ↙68 cm	↔61 cm ↑2 cm ↙5 cm							
Article	Price	<b>5SY0</b>	<b>5SY1</b>	<b>5SY2</b>	<b>9DM1</b>						

WARDROBES		Passepartouts in application colour, without lighting, for sliding door wardrobes.						
						passepartout	passepartout	passepartout
						for sliding wardrobe 200cm	for sliding wardrobe 250cm	
	↔209 cm ↑226 cm ↙16 cm	↔259 cm ↑226 cm ↙16 cm	↔309 cm ↑226 cm ↙16 cm					
Article	Price	<b>9PC5</b>	<b>9P69</b>	<b>9PF9</b>				

WARDROBES		Passepartouts in application colour, with lighting, for sliding door wardrobes.			Lighting			
						passepartout	passepartout	passepartout
						for sliding wardrobe 200cm with lighting	for sliding wardrobe 250cm with lighting	with lighting
	↔209 cm ↑226 cm ↙16 cm	↔259 cm ↑226 cm ↙16 cm	↔309 cm ↑226 cm ↙16 cm					
Article	Price	<b>9PC4</b>	<b>9P67</b>	<b>9PF8</b>	<p>This product contains a light source of the energy efficiency class E. EPREL 766798</p>			

# ACCESSORIES 1.0

rauch ORANGE +

for hinged/sliding door wardrobes  
Element width 50, 75, 100 cm



Colour	Colour code
Texline (Linen look in natural hues)	A0066



Texline

Supplier: Rauch Möbelwerke GmbH

# ACCESSORIES 1.0

rauch ORANGE +

for hinged/sliding door wardrobes Element width 50, 75, 100 cm

These wardrobe widths are comprised of the following units:

	Sliding door wardrobes, 2-door	Options for installing drawer units, Trousers pull-outs, Clothes lifts and pull-out shelves in sliding door wardrobes	Sliding door wardrobes, 3-door	Options for installing drawer units, Trousers pull-outs, Clothes lifts and pull-out shelves in sliding door wardrobes	Sliding door wardrobes with drawers	Options for installing drawer units, Trousers pull-outs, Clothes lifts and pull-out shelves in sliding door wardrobes
↔ 151 cm						
↔ 201 cm		 928D 928D 9584 9584 9588 9588				 928D 928D 9584 9584 9588 9588
↔ 226 cm						
↔ 251 cm		 97R1 99R1 9582 928D 9586 9314 9588 9584 9588 9588				
↔ 301 cm		 99R1 99R1 928D 928D 9314 9314 9584 9584 9588 9588		 928D 928D 928D 9584 9584 9584 9588 9588 9588		 928D 928D 928D 9584 9584 9584 9588 9588 9588

These wardrobe widths are comprised of the following units:

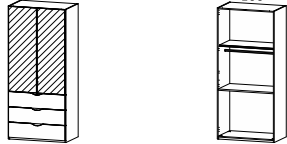
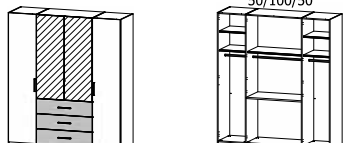
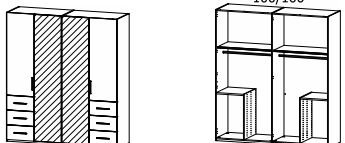
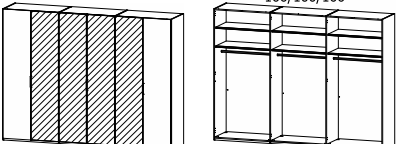
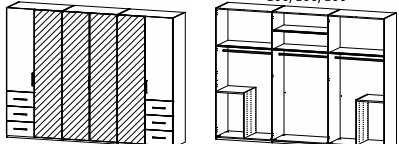
	Hinged door wardrobes	Hinged door wardrobes with drawers in the middle	Hinged door wardrobes with drawers at the side
↔ 101 cm	 <p>100</p>	 <p>100</p>	 <p>50/50</p>
↔ 151 cm	 <p>100/50</p>	 <p>50/50/50</p>	 <p>50/100</p>
↔ 201 cm	 <p>100/100</p>	 <p>50/100/50</p>	 <p>100/100</p>
↔ 251 cm	 <p>100/50/100</p>	 <p>100/50/100</p>	 <p>100/50/100</p>
↔ 301 cm	 <p>100/100/100</p>	 <p>100/100/100</p>	 <p>100/100/100</p>





# ACCESSORIES 1.0





rauch ORANGE +

for hinged/sliding door wardrobes



Element width **50, 75, 100 cm**

Colour	Colour code
Textline (Linen look in natural hues)	A0066

ELEMENT WIDTH ▶		50	50	50	50
				 *	
		<b>Shelves</b> for unit width 50cm ↔48 cm †2 cm ↗50 cm	<b>hanging rail</b> for unit width 50cm ↔48 cm †3 cm ↗2 cm	<b>pull-out shelf</b> for unit width 50cm ↔48 cm †9 cm ↗49 cm	<b>drawer division</b> for pull-out shelf for unit width 50cm ↔36 cm †5 cm ↗44 cm
	1 pieces	Price	<b>9643</b>	<b>9739</b>	<b>97R1</b>
Set of 2		<b>97F6</b>			
Set of 3		<b>9633</b>			
Set of 4		<b>99J6</b>			

ELEMENT WIDTH ▶		50	50	50	
			 *	 *	<p>* Please note: Please be sure to observe the installation options for sliding door wardrobes.</p>
		<b>1 glass shelf</b> for pull-out shelf for unit width 50cm ↔48 cm †1 cm ↗49 cm	<b>interior drawer</b> with 2 drawers for unit width 50cm ↔48 cm †45 cm ↗50 cm	<b>interior drawer</b> with 3 drawers for unit width 50cm ↔48 cm †64 cm ↗50 cm	
	Article	Price	<b>9G5B</b>	<b>9S82</b>	

Colour	Colour code
Texline (Linen look in natural hues)	A0066

ELEMENT WIDTH ▶		75	75		
					
		<b>1 shelf</b> for unit width 75 cm ↔73 cm †2 cm ↗50 cm	<b>hanging rail</b> for unit width 75 cm ↔73 cm †3 cm ↗2 cm		
1 pieces	Price	<b>96F1</b>	<b>97K0</b>		
Set of 2		<b>96F2</b>			
Set of 3		<b>96F3</b>			
Set of 4		<b>96F4</b>			

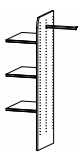
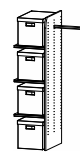
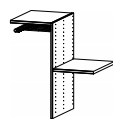
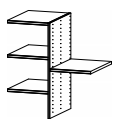
ELEMENT WIDTH ▶		75	75	75	75
can be mounted on the left or right		 <b>NEW</b> AVAILA- BLE FROM 06/2022	 <b>NEW</b> AVAILA- BLE FROM 06/2022	 <b>NEW</b> AVAILA- BLE FROM 06/2022	 <b>NEW</b> AVAILA- BLE FROM 06/2022
		<b>interior division</b> for unit width 75cm with clothes rail with 3 shelves ↔73 cm †148 cm ↗51 cm	<b>interior division</b> for unit width 75cm incl. 4 fabric boxes ↔73 cm †148 cm ↗51 cm	<b>interior division</b> for unit width 75cm with trouser holder ↔73 cm †80 cm ↗51 cm	<b>interior division</b> for unit width 75cm with 4 shelves ↔73 cm †80 cm ↗51 cm
	Article	Price	<b>9SJ4</b>	<b>9ZS7</b>	<b>9ZH7</b>





# ACCESSORIES 1.0



rauch ORANGE +

for hinged/sliding door wardrobes

Element width 50, 75, **100** cm

\* Please note: Please be sure to observe the installation options for sliding door wardrobes.



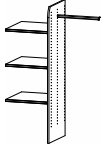
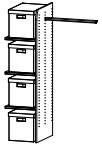
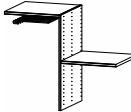
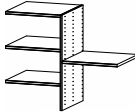

ELEMENT WIDTH ▶		100	100	100	100
					
		<b>Shelves</b> for unit width 100cm ↔98 cm †2 cm ↗50 cm	<b>hanging rail</b> for unit width 100cm ↔98 cm †3 cm ↗2 cm	<b>pull-out shelf</b> for unit width 100cm ↔98 cm †9 cm ↗49 cm	<b>drawer division</b> for pull-out shelf for unit width 100cm ↔86 cm †5 cm ↗44 cm
1 pieces	Price	<b>9641</b>	<b>9738</b>	<b>99R1</b>	<b>96T4</b>
Set of 2		<b>97F9</b>			
Set of 3		<b>9631</b>			
Set of 4		<b>99J9</b>			



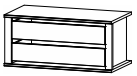

ELEMENT WIDTH ▶		100	100	100	100
					
		<b>1 glass shelf</b> for pull-out shelf for unit width 100cm ↔98 cm †1 cm ↗49 cm	<b>1 shelf</b> with trouser pull-out for unit width 100cm ↔98 cm †10 cm ↗51 cm	<b>clothes lift</b> ↔98 cm †84 cm ↗14 cm	
Article	Price	<b>9G5D</b>	<b>9Z8D</b>	<b>9314</b>	

ELEMENT WIDTH ▶		100	100	100	100
can be mounted on the left or right			 <b>NEW</b> AVAILA-BLE FROM 06/2022	 <b>NEW</b> AVAILA-BLE FROM 06/2022	 <b>NEW</b> AVAILA-BLE FROM 06/2022
		<b>interior division</b> with 3 shelves with clothes rail for unit width 100cm ↔98 cm †148 cm ↗51 cm	<b>interior division</b> for unit width 100cm incl. 4 fabric boxes ↔98 cm †148 cm ↗51 cm	<b>interior division</b> for unit width 100cm with trouser holder ↔98 cm †80 cm ↗51 cm	<b>interior division</b> for unit width 100cm with 4 shelves ↔98 cm †80 cm ↗51 cm
Article	Price	<b>9SJ6</b>	<b>9ZS0</b>	<b>9ZH0</b>	<b>9ZK0</b>

Colour	Colour code
Texline (Linen look in natural hues)	A0066

\* Please note: Please be sure to observe the installation options for sliding door wardrobes.

ELEMENT WIDTH ▶		100	100	100	100
		*	*		
				wardrobe division	wardrobe division
		interior drawer with 2 drawers for unit width 100cm	interior drawer with 3 drawers for unit width 100cm	with 3 drawers with 2 shelves for unit width 100cm	with 3 drawers with 4 shelves for unit width 100cm
		↔98 cm †45 cm ↗50 cm	↔98 cm †64 cm ↗50 cm	↔98 cm †64 cm ↗51 cm	↔98 cm †103 cm ↗51 cm
Article	Price	<b>9S84</b>	<b>9S88</b>	<b>9SC6</b>	<b>9SD6</b>



		for corner robe	for corner robe	Cupboard extras	
					
		Shelves for interior division corner 45°	set of 3 shelves for interior division corner 45°	interior division for drawer 80 cm plexiglass	
		↔88 cm †2 cm ↗50 cm	↔43 cm †2 cm ↗26 cm	↔73 cm †9 cm ↗34 cm	
1 pieces	Price	<b>9642</b>		<b>9ZP8</b>	
Set of 2		<b>97F8</b>			
Set of 3		<b>9632</b>	<b>96B3</b>		
Set of 4		<b>99J8</b>			





# ACCESSORIES 1.0

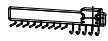

rauch ORANGE +

General



Colour	Colour code
Texline (Linen look in natural hues)	A0066

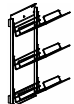

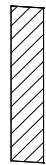

GENERAL					
					
		tie rack	tie/belt rack	tie/belt rack	extending rail holder
		swivelling		pull-out	
		↔32 cm ↓27 cm ↗6 cm	↔10 cm ↓13 cm ↗46 cm	↔9 cm ↓6 cm ↗45 cm	↔31 cm ↓6 cm ↗4 cm
Article	Price	<b>9768</b>	<b>990K</b>	<b>9GK1</b>	<b>9760</b>

GENERAL					
					
		hooks	trouser holder	coat hanger rail	coat hanger rail
					swivelling
		↔35 cm ↓5 cm ↗5 cm	↔25 cm ↓7 cm ↗46 cm	↔7 cm ↓52 cm ↗28 cm	↔20 cm ↓35 cm ↗3 cm
Article	Price	<b>9HL1</b>	<b>990H</b>	<b>9767</b>	<b>9769</b>

GENERAL					
		Can only be mounted on the outer or middle panels. Maximum load per basket 11 kg.	Can only be mounted on the outer or middle panels. Maximum load per shoe rack 4 kg.	Max load 7 kg.	
					
		st of 3 metal bsks	set of 3 shoe racks	laundry basket	
				with pull-out	
		↔35 cm ↓62 cm ↗50 cm	↔26 cm ↓66 cm ↗50 cm	↔30 cm ↓55 cm ↗50 cm	
Article	Price	<b>9AZ5</b>	<b>9AZ6</b>	<b>9WK1</b>	

Colour	Colour code
Texline (Linen look in natural hues)	A0066

GENERAL				
				
			interior mirror for hinged doors	interior mirror, for sliding doors mirror width 31 cm hinged extends from 45 to 73 cm
			↔29 cm ↓130 cm ↗0 cm	↔46 cm ↓115 cm ↗4 cm
Article	Price	<b>98S8</b>	<b>9408</b>	

GENERAL		Door dampers rauch EASY SLIDE			
					
				Installation not possible on wardrobes with front lighting.	Installation not possible on wardrobes with front lighting.
				set of 2 dampers for sliding wardrobes EASY SLIDE of 2-4 door sliding door wardrobes	damper for middle door EASY SLIDE of 3 door Sliding door wardrobes
	↔61 cm ↓2 cm ↗5 cm	↔28 cm ↓2 cm ↗4 cm	↔14 cm ↓9 cm ↗2 cm		
Article	Price	<b>9DM1</b>	<b>9DM4</b>	<b>9DM6</b>	

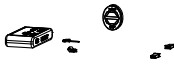
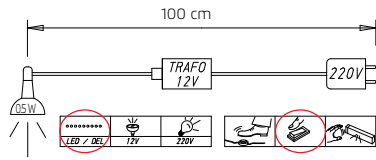
LIGHTING					
					
				interior lights with motion sensor LED light	lighting control with handheld transmitter
				↔23 cm ↓2 cm ↗11 cm	
Article	Price	<b>9T1B</b>	<b>99FB</b>		

# ACCESSORIES 1.0

rauch ORANGE +

General

Colour	Colour code
Texline (Linen look in natural hues)	A0066

LIGHTING		BALENO		
		LED bar lamp	LED bar lamp	This product contains a light source of the energy efficiency class E. EPREL 768436
		↔90 cm ↕6 cm ↗19 cm	↔90 cm ↕6 cm ↗19 cm	
Article	Price	<b>9W1L</b>	<b>9S1L</b>	

LIGHTING		LUCIDO	NEELA	LUNA	LOFT
		set of 2 LED lights	set of 2 LED lights	set of 2 LED lights	set of 2 LED lights
		↔27 cm ↕7 cm ↗14 cm	↔89 cm ↕6 cm ↗18 cm	↔21 cm ↕9 cm ↗33 cm	↔33 cm ↕5 cm ↗18 cm
Set of 2	Price	<b>9L42</b>	<b>9L62</b>	<b>94L2</b>	<b>9C74</b>
Set of 3		<b>9L43</b>		<b>94L3</b>	<b>9C76</b>

LIGHTING		LUCIDO	NEELA	LUNA	LOFT
		This product contains a light source of the energy efficiency class F. EPREL 936418	This product contains a light source of the energy efficiency class E. EPREL 766774	This product contains a light source of the energy efficiency class E. EPREL 766798	This product contains a light source of the energy efficiency class G. EPREL 766530